

THINK SAFETY FIRST

Practice Safety First. Safety starts with you! YOU MUST READ, UNDERSTAND AND FOLLOW ALL WARNINGS AND INSTRUCTIONS IN THE INCLUDED INSTRUCTION MANUAL AND ALL OTHER INSTRUCTIONAL MATERIALS PROVIDED BEFORE USING THIS CROSSBOW.



OWNERS INSTRUCTION MANUAL

MODEL 1106 – BURNER 415

YOU MUST READ, UNDERSTAND AND FOLLOW ALL WARNINGS AND INSTRUCTIONS IN THIS MANUAL BEFORE USING THIS CROSSBOW!

⚠ WARNING

CONTACT KILLER INSTINCT® AT 810-626-3026 OR CONTACT@KILLERCROSSBOWS.COM WITH QUESTIONS.

FAILURE TO FOLLOW THESE INSTRUCTIONS CAN RESULT IN SERIOUS INJURY OR DEATH!

WARNINGS OF GREAT IMPORTANCE ARE FOUND ON FOLLOWING PAGES:

Introduction	2	Cocking Crossbow	10
Safety Information	3	Hand Placement	12
No Alterations	4	Loading & Shooting	13
Manual Safety	9	Unloading	13
Crossbow Arrow Safety	10		

OTHER WARNINGS AND CAUTIONS APPEAR THROUGHOUT THE MANUAL.



**REGISTER ONLINE FOR
LIMITED LIFETIME GUARANTEE!**

Register at:

[HTTPS://WWW.KILLERCROSSBOWS.COM/REGISTER](https://www.killercrossbows.com/register)

KEEP INSTRUCTION MANUAL WITH CROSSBOW

THIS INSTRUCTION MANUAL MUST ALWAYS ACCOMPANY THIS CROSSBOW AND BE TRANSFERRED WITH IT UPON CHANGE OF OWNERSHIP, WHEN LOANED, OR PRESENTED TO ANOTHER PERSON.

TABLE OF CONTENTS

Introduction	2
Safety Information	3
No Alterations	4
Nomenclature	4
Crossbow Assembly	6
Trigger Box & Anti-Dry Fire	9
Manual Safety	9
Crossbow Arrow Safety	10
Cocking Crossbow	10
Proper Finger, Thumb & Hand Placement	12
Loading & Shooting	13
Unloading	13
Maintenance, Care & Storage	14
Trouble Shooting & Records	15
Warranty	16
Notes	17
Registration	18

QUESTIONS? - CONTACT CUSTOMER SERVICE



810-626-3026



HUNTKILLERINSTINCT.COM



CONTACT@KILLERCROSSBOWS.COM

12-2019-00

INTRODUCTION

Congratulations on your new Killer Instinct® crossbow purchase! Thank you for your support. Your crossbow has been designed, manufactured, tested, and delivered to be safe when used with all the instructional information provided. Before assembly, make the first step with your new crossbow be to read and thoroughly understand all the information and instructional materials included with this product. Read and understand the Owners Instructional Manual from cover to cover. **YOU MUST READ, UNDERSTAND AND FOLLOW ALL WARNINGS AND INSTRUCTIONS IN THIS MANUAL BEFORE USING THIS CROSSBOW! THIS INCLUDES ANY INFORMATION PROVIDED ON THE CROSSBOW, ARROWS, PACKAGING, HARDWARE, ACCESSORIES, OR OTHER ITEMS PROVIDED. CONTACT KILLER INSTINCT® AT 810-626-3026 OR CONTACT@KILLERCROSSBOWS.COM WITH ANY QUESTIONS. FAILURE TO FOLLOW THESE INSTRUCTIONS CAN RESULT IN SERIOUS INJURY OR DEATH!** When used in accordance with all the instructional information provided and with proper care and maintenance, your crossbow will provide years of service. Keep and save all instructional materials provided. If crossbow transfers ownership, loaned or presented to another person, Owners Instruction Manual must be kept with crossbow and new owner/borrower must read and understand all instructions and warnings in the Owners Instruction Manual before using crossbow.

A crossbow is a deadly weapon! As such, crossbows should be treated as firearms in regards to care and safety.

The five basic rules of firearms & crossbows safety:

- Always point a firearm/crossbow in a safe direction.
- Treat every firearm/crossbow as if it were loaded and never assume a firearm/crossbow is unloaded.
- Keep your finger out of the trigger guard and off the trigger until ready to shoot.
- Keep all parts of body and clothing out of path of bow string and cables of crossbow and out of path of projectile of firearm/crossbow.
- Be sure of your target and what is beyond your target.

Crossbows by design, use a bow string and shoot projectiles at high rates of speed and should only be used by those that have completed a Hunter's Safety Course or trained by a qualified professional. Always use caution to keep all parts of body and clothing out of path of bow string and cables. High speed moving bow strings can cause serious injury if contact occurs such as finger and thumb amputation. Know your target. Projectiles that do not remain on target can cause serious injury or death. Wear safety glasses when cocking, loading and shooting any crossbow. Think Safety First and Practice Safety First. Safety Starts with You! **YOU MUST READ, UNDERSTAND AND FOLLOW ALL WARNINGS AND INSTRUCTIONS IN THIS MANUAL AND ALL OTHER INSTRUCTIONAL MATERIALS PROVIDED BEFORE USING THIS CROSSBOW**

WARNING

CROSSBOW USE IS FOR EXPERIENCED USERS ONLY! CROSSBOWS SHOULD ONLY BE USED BY THOSE THAT HAVE COMPLETED A HUNTER'S SAFETY COURSE OR TRAINED BY A QUALIFIED PROFESSIONAL.

QUESTIONS? - CONTACT CUSTOMER SERVICE



810-626-3026



HUNTKILLERINSTINCT.COM



CONTACT@KILLERCROSSBOWS.COM

Page 2 of 18 12-2019-00

IMPORTANT SAFETY INFORMATION:

Crossbow is a deadly weapon! Always keep crossbow pointed in safe direction. Never point at or toward person(s) or at or toward anything you do not intend to shoot.

Always be certain of intended target and what is beyond it before shooting. Never shoot at noise or movement.

Always be aware of your surroundings and ensure no other person or animal is between you and target area.

Always make certain others are well behind you before you shoot.

Never shoot straight up or in any direction that may endanger people or other objects.

Never shoot at hard surfaces or at surface of water. Arrow may bounce back or ricochet and hit someone or an unintended target.

Always keep thumb and fingers below flight rail, string, barrel and behind cables.

Always keep all parts of body and clothing out of path of bow string and cables.

To prevent accidental discharge, always keep crossbow safety on 'SAFE'. Only position safety to 'FIRE' when ready to shoot.

Never dry fire crossbow (fire without arrow loaded). This will void warranty, damage crossbow.

Never put your finger on trigger until you are ready to shoot as you could accidentally fire crossbow causing serious injury or death.

Never store or transport crossbow in cocked or loaded position. Accidental discharge could occur.

Keep crossbow out of reach of children!

When hunting from treestands or at heights always wear full body harness (not included) that has been certified by a Third-Party Testing Facility that meets or exceeds Industry Standards.

FAILURE TO FOLLOW THESE INSTRUCTIONS CAN RESULT IN SERIOUS INJURY OR DEATH!

WARNING

- Do not modify crossbow or remove or deactivate crossbow's safety features.
- Never walk, stalk, or carry crossbow with arrow loaded in crossbow. It is acceptable to carry a cocked but unloaded crossbow.
- Never fire crossbow if branches, tree, blind windows/walls, or obstructions may contact crossbow or crossbow limbs in its release path.
- Always keep crossbow string and cables away from sharp objects as they may cut string or cables. DO NOT use if string or cables are cut or show signs of wear, contact KILLER INSTINCT® at 810-626-3026 or e-mail support at contact@killercrossbows.com or take to an authorized KILLER INSTINCT® dealer for inspection.
- If under age of 18 do not use without adult supervision.
- Always place broadheads in quiver when transporting or storing crossbow to prevent contact with string/cables.
- Never use crossbow while taking or under influence of drugs (even prescription drugs) or alcohol.
- Wear safety glasses when cocking, loading and shooting any crossbow.
- Always obey all safety rules and laws covering ownership and use of this crossbow in your state, hunting or shooting area. Locate and read all such rules prior to using crossbow.
- Only use crossbow for intended use of hunting and target shooting. Do not use for any other purpose!

QUESTIONS? - CONTACT CUSTOMER SERVICE



810-626-3026



HUNTKILLERINSTINCT.COM



CONTACT@KILLERCROSSBOWS.COM

Page 3 of 18 12-2019-00

IMPORTANT SAFETY INFORMATION CONTINUED:

- Do not climb up or down a tree with crossbow or hoist loaded crossbow. Always unload crossbow and use hoist rope to lift up and down tree or elevated hunting platform.
- Never modify your crossbow in any way by making repairs, replacing parts, altering, adding or attaching anything to it other than Killer Instinct® accessories designed specifically for Killer Instinct® crossbows.
- When target practicing, always setup proper crossbow target and backstop in safe open area with nothing beyond target you do not intend to shoot.
- When cocking crossbow use proper lifting techniques to avoid injury to back (lift with arms and shoulders).
- Never use this product when feeling ill, nauseous, dizzy or if you have preexisting medical condition that could cause a problem cocking or shooting crossbow.
- Examine crossbow and arrows after every shot for worn, loose, damaged or missing parts and cracks or damage to arrows. If damage is suspected, DO NOT use crossbow and arrow(s), contact KILLER INSTINCT® at 810-626-3026 or e-mail support at contact@killercrossbows.com.
- Do not use crossbow if it is not in top working condition, contact KILLER INSTINCT® at 810-626-3026 or e-mail support at contact@killercrossbows.com for assistance.

NO ALTERATIONS OR ADJUSTMENTS:



Do not modify, remove, or deactivate crossbow's safety features.
Do not modify crossbow in any way by making repairs, replacing parts, altering, adding or attaching anything to it.
FAILURE TO FOLLOW THESE INSTRUCTIONS CAN RESULT IN SERIOUS INJURY OR DEATH!

NO ALTERATIONS:

This product is designed to function properly in its original condition. Alterations can make it unsafe. Do not alter, add, or substitute parts or accessories not made by KILLER INSTINCT®.

NO ADJUSTMENT – LIMB BOLTS:

Do not attempt to adjust limb bolts by tightening or loosening bolts. Limb bolts are factory adjusted to specific torque specifications to optimize crossbow performance.

Do not attempt to change string, cables or limbs without proper tools and instruction. Always have qualified Killer Instinct™ professional or authorized KILLER INSTINCT® dealer perform these maintenance procedures.

NOTE: A crossbow press and qualified technician is required to change/install string, cables, limbs, cam assemblies, etc.

BURNER 415 NOMENCLATURE:

- Unpack and Check
- Review & Confirm all items are included in Parts List. If they are not, stop and contact KILLER INSTINCT® customer service before continuing or using this product.

QUESTIONS? - CONTACT CUSTOMER SERVICE



810-626-3026



HUNTKILLERINSTINCT.COM



CONTACT@KILLERCROSSBOWS.COM

Page 4 of 18 12-2019-00

!! DO NOT RETURN TO STORE !!

UNPACK to assure all items are included.

If an item is missing, CONTACT KILLER INSTINCT® CUSTOMER SERVICE

PARTS LIST:

Qty	Part No.	Description
1	SPK-1106-FSA_____	BURNER 415 Stock Assembly (Stock, Trigger Box, Buttstock, Forearm Grip, Pistol Grip w/Hardware).
1	SPK-1106-FE_____	BURNER 415 Front End Assembly (Riser Assembly, Limb Set, Cam Assembly Set, Cables, String, String Suppressor Set w/ Dampeners, Limb Dampeners, String Leech, Front End Assembly Hardware).
1	SPK-0007_____	Cable Slide
1	SPK-1049_____	Fixed Foot Stirrup and Assembly Hardware
1	SPK-LUMIX-WR_____	Lumix 4x32 IR-W w/Scope Rings and Assembly Hardware (CR2032 Battery).
1	SPK-1116-B_____	Rail Lube
1	SPK-1070_____	Rope Cocker
1	SPK-1079_____	3-Bolt Quiver & Mount Assembly
3	SPK-1065-288_____	20" HYPR™ Lite Bolts w/Half Moon Nocks & 100 Gr. 11/32 Field Points
1	SPK-BURNER415-IM_____	Instructions and Safety Manual

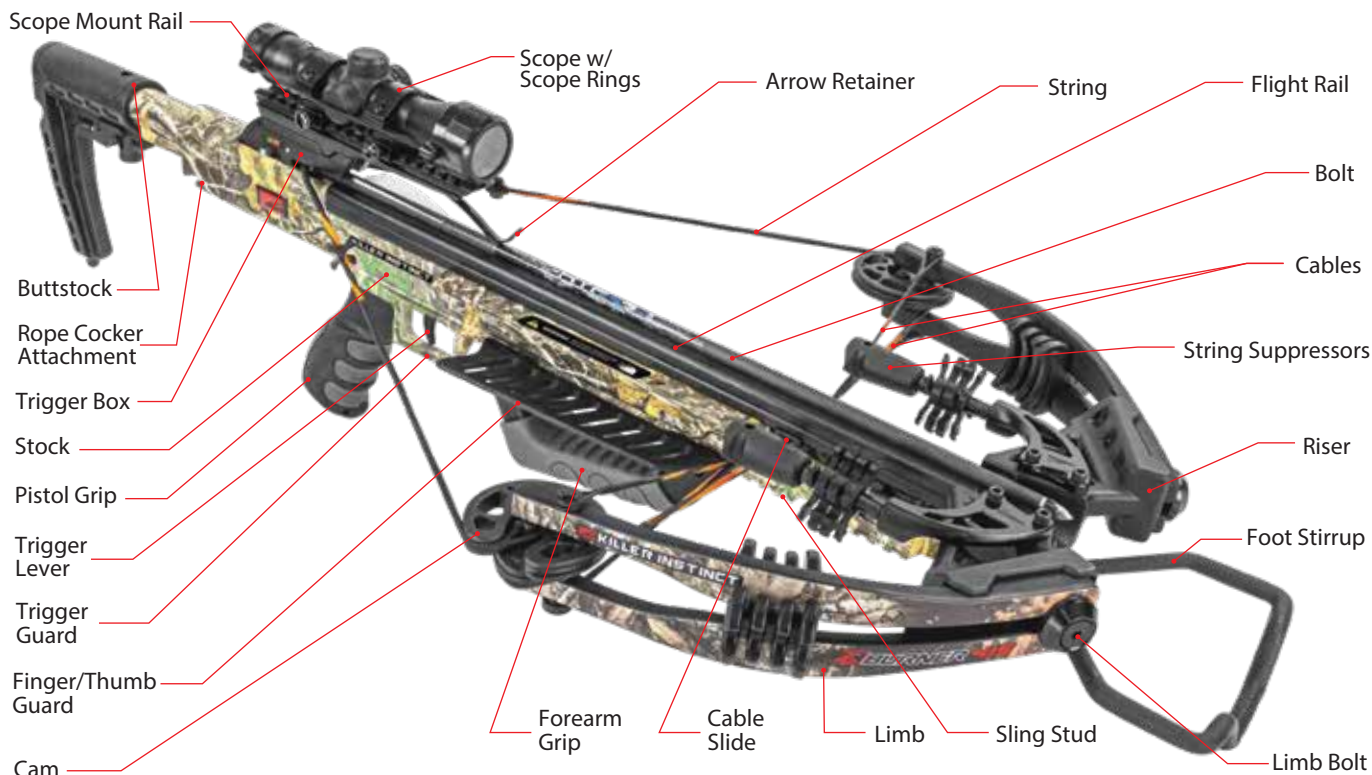

Note: Actual model may differ than one shown. Not shown: Quiver system (accessories may not apply to some models).



KEEP THUMB / FINGERS ON FOREARM GRIP AND BELOW BELOW FLIGHT RAIL AND CABLES



QUESTIONS? - CONTACT CUSTOMER SERVICE



810-626-3026



HUNTKILLERINSTINCT.COM



CONTACT@KILLERCROSSBOWS.COM

BURNER 415 CROSSBOW ASSEMBLY:

RAIL LUBE

PRIOR TO ASSEMBLY apply Rail Lube to string, cables, both sides of cable slide, and flight rail. RAIL LUBE MUST BE APPLIED TO STRING, CABLES AND FLIGHT RAIL ON REGULAR BASIS TO PREVENT WEAR. Apply as often as needed or when rail lube appears to have worn off flight rail, string or cables.

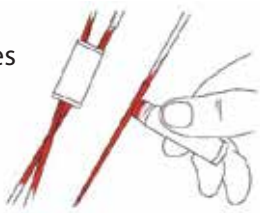

DO NOT MODIFY CROSSBOW!
QUESTIONS CALL 810-626-3026

ATTACHING FRONT END TO BARREL AND INSTALLING FOOT STIRRUP

STEP #1 INSTRUCTION: Flip riser over as shown (bottom of riser is up) and attach Cable Slide to cables with flat side of Cable Slide down. Cables fit into grooves on Cable Slide so wedge on cable slide is in between cables and cables cross to right of cable slide. Note – Place cables in groove that matches height on cable slide. Flip riser over (top of riser is up) and double check cables cross on Left side, wedge is between cables and cables are underneath Cable Slide.

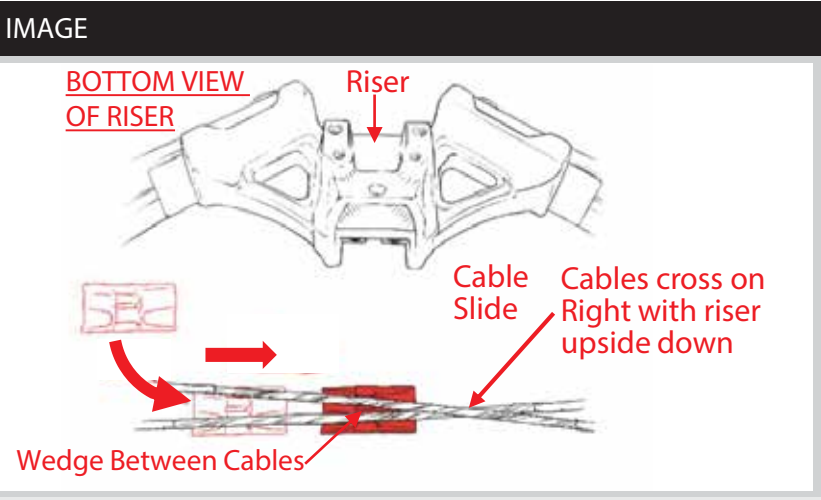

STEP #2 INSTRUCTION: Holding Cable Slide in place (cables underneath Cable Slide), insert Cable Slide and cables into cable slot. Continue inserting Cable Slide and cables into slot while keeping string on TOP of barrel.

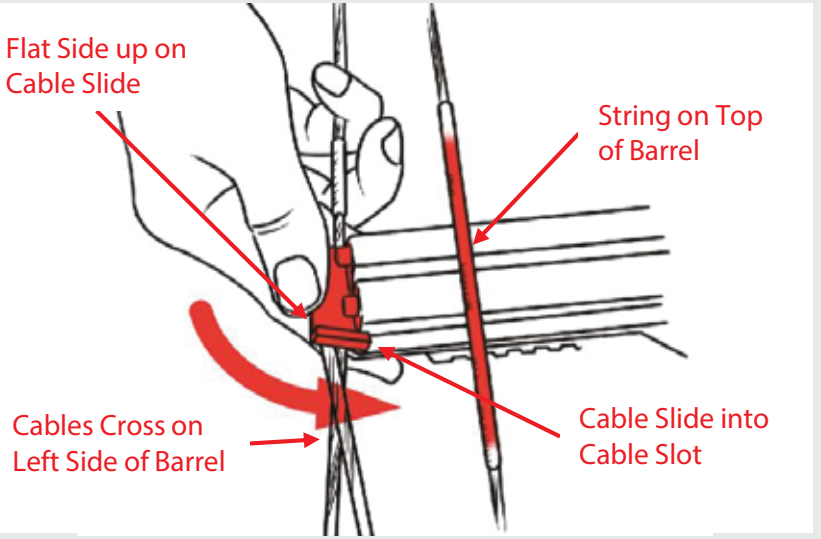

CAREFULLY INSERT CABLES AND CABLE SLIDE INTO BARREL SLOT TO PREVENT CABLE PINCHING OR CABLE CONTACT WITH EDGES OF BARREL! CABLE SLIDE MUST BE INSTALLED BEFORE ATTACHING FRONT END!
 QUESTIONS CALL 810-626-3026

STEP #3 INSTRUCTION: Push riser completely over top of barrel, making sure riser lines up with barrel.

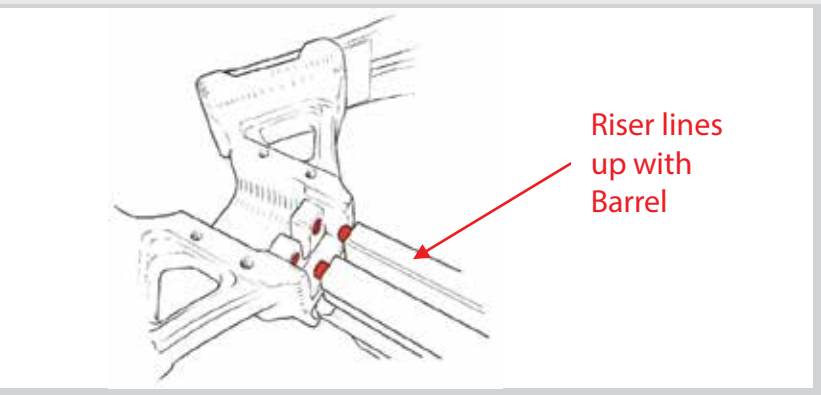

QUESTIONS? - CONTACT CUSTOMER SERVICE

BURNER 415 CROSSBOW ASSEMBLY CONTINUED:

STEP **INSTRUCTION**

#4 With cable slide and bowstring properly positioned, assemble riser onto the barrel by using 33mm (Qty 2) bolts as shown.

Turn riser over and assemble 21mm bolt as shown.

Double check that all 3 bolts are securely tightened.

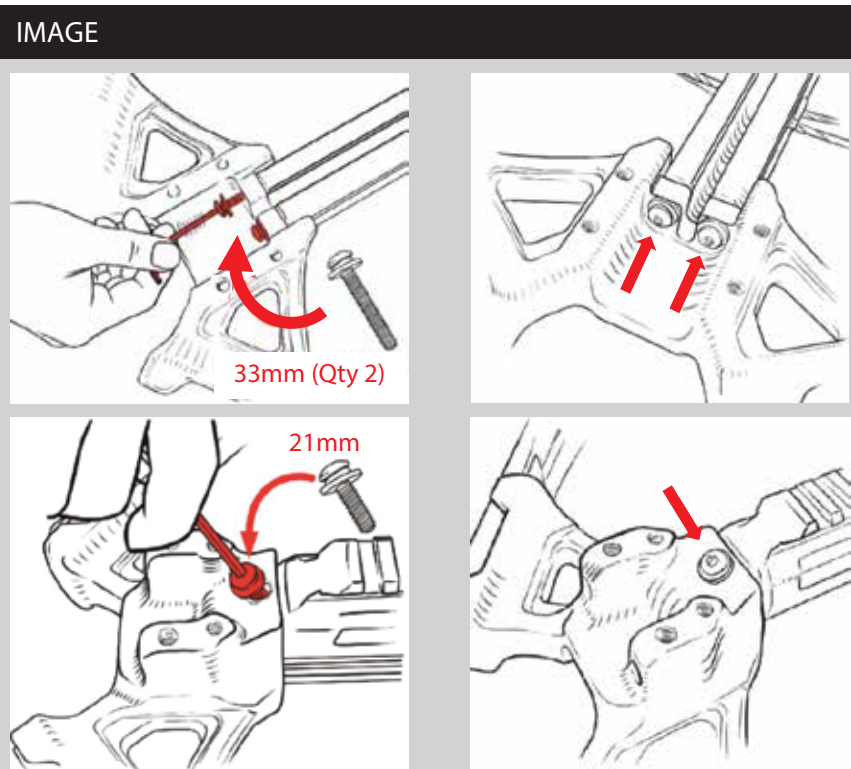

#5 Insert foot stirrup to front of riser so foot stirrup notches (facing up) line up with vertical screw holes in riser.

Using included set screws securely tighten foot stirrup to riser as shown.

Double check that all bolts are securely tightened.

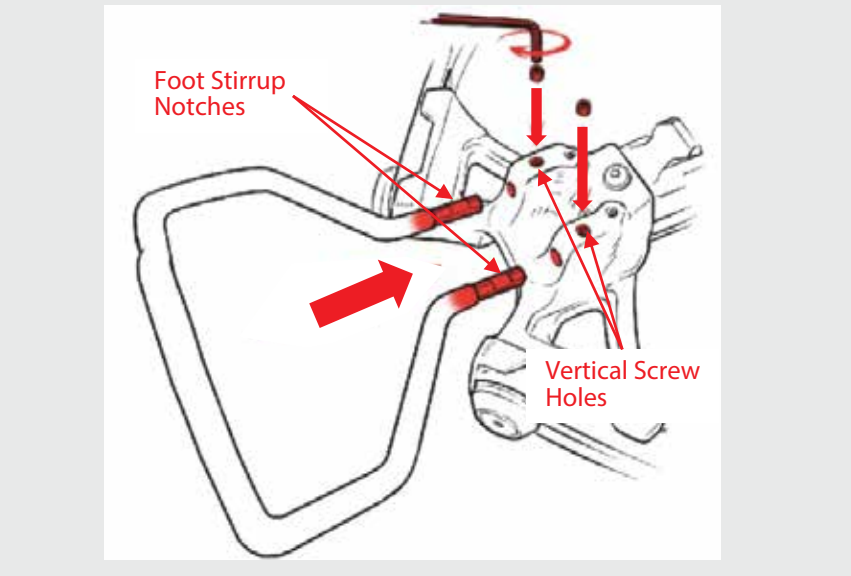

QUIVER, SCOPE AND STRING SUPPRESSOR ASSEMBLY:

STEP	INSTRUCTION	IMAGE
QUIVER	<p>Attach quiver mounting bracket to back of the riser by using included hardware. Attach quiver base to quiver using included hardware. Attach quiver to quiver mounting bracket. Close locking lever.</p>	
	<p>For side-mount bracket, attach side-mount bracket to picatinny rail on bottom of crossbow stock using included hardware. Slide quiver into side-mount bracket. Close locking lever.</p>	
SCOPE	<p>Position scope by moving it forward or backward until proper eye relief is achieved. This is typically 3 to 4 inches from your eye to the eyepiece when holding crossbow in shooting position. Tighten scope rings to scope with provided Allen wrench. Tighten scope rings to picatinny rail with screw driver or coin.</p>	
STRING SUPPRESSOR	<p>Position string suppressor so gap between suppressor and string is approximately 1/32" wide (about the width of a credit card). Securely tighten screws.</p>	

QUESTIONS? - CONTACT CUSTOMER SERVICE

KI TRIGGER BOX AND ANTI-DRY FIRE (BURNER 415 MODEL):

WARNING

Never deactivate Anti-Dry Fire mechanism and move safety to 'FIRE' when crossbow arrow is not loaded. This deactivates Anti -Dry Fire allowing crossbow to be dry fired. Never Dry Fire crossbow. This will void warranty and may cause serious injury or death.
Always keep crossbow safety in 'SAFE' position until ready to shoot.



ANTI-DRY FIRE RELEASE MECHANISM:

Mechanism prevents crossbow from firing when there is no arrow/bolt loaded in crossbow.

OPERATION OF MANUAL SAFETY (BURNER 415 MODEL):

WARNING

Even though crossbow is equipped with auto engaging safety, always check to assure safety is in 'SAFE' position when crossbow is in cocked position.
Always keep crossbow safety in 'SAFE' position until ready to shoot.

INSTRUCTION

SAFETY IN 'SAFE' (GREEN DOT) POSITION

Safety is in 'SAFE' position when manual safety is in back position next to green dot (furthest from string)



Always keep crossbow safety in 'SAFE' position until ready to shoot.

IMAGE



SAFETY IN 'FIRE' (RED DOT) POSITION

Safety is in 'FIRE' position when safety is in forward position next to red dot (closest to string)



Crossbow will fire when trigger is pulled.



QUESTIONS? - CONTACT CUSTOMER SERVICE

CROSSBOW ARROW/BOLT SAFETY:

WARNING

Only use arrow(s) with half moon nocks.

Only use finished arrow(s) (arrow and point) weighing at least 370 grains and minimum length 20 inches. Under weight arrows can damage crossbow.

Failure to follow these instructions can result in serious injury or death!

CROSSBOW ARROW/BOLT SELECTION:

Always use a finished arrow(s) (arrow and point) weighing at least 370 grains and minimum length of 20 inches.

Always use arrow(s) with half moon nocks.

Always use field point or broadhead installed on arrow. NEVER SHOOT CROSSBOW ARROW WITHOUT FIELD POINT OR BROADHEAD.

WARNING

Always inspect arrow(s) before every shot for damage including but not limited to bends, cracks, nicks, cuts, fractures, damaged nock, missing insert or point. DO NOT SHOOT A DAMAGED ARROW OR IF DAMAGE IS SUSPECTED.

View www.safearrow.info for instructions to inspect bolts.

Failure to follow these instructions can result in serious injury or death!

INSPECTING CROSSBOW ARROWS/BOLTS:

Always inspect arrow prior to every shot. View www.safearrow.info for instructions on how to inspect arrows.

Damage can occur from impacts with hard objects, other arrows or after being shot into a game animal. A damaged arrow can break upon shot resulting in injury to you, bystanders and damage crossbow.

1. Slowly run your fingers along entire length of arrow and nock, feeling and looking for bends, cracks, nicks, cuts, fractures, splits, dents or other marks that could indicate damage. If damaged or suspect damage do not shoot arrow.
2. Grab arrow above point and below nock, then flex arrow (bending away from you and others) with 0.5 to 1 inch deflection and listen for cracking noises. Repeat 5 or 6 times rotating arrow between each flex. If you feel or hear cracking, arrow has been damaged. Do not shoot arrow.
3. While holding both ends of arrow, twist shaft in both directions. If arrow relaxes or twists easily, arrow has been damaged. Do not shoot arrow.
4. Always check all arrow components prior to shooting. Tighten loose components. Loose components can cause unbalanced flight and may partial dry fire crossbow.

WARNING

Never shoot crossbow arrow(s) if you observe or suspect damage!

Discard damaged arrow.

COCKING CROSSBOW:

WARNING

Do not cock crossbow by hand as possible back, shoulder or finger injuries may occur. Always use rope cocking device to cock crossbow.

Never cock or use crossbow when feeling ill, nauseous, dizzy or if you have prior medical condition that could cause a problem cocking or shooting crossbow.

When cocking crossbow use proper lifting techniques to avoid injury to back (lift with arms and shoulders).

Do not de-cock crossbow with a cocking device or by any other means. (See UNLOADING CROSSBOW section on page 13 to de-cock crossbow)

USING ROPE COCKING DEVICE:

IMPORTANT NOTE: ALWAYS USE ROPE COCKING DEVICE. THESE DEVICES EVENLY PULL STRING TO COCKED POSITION RESULTING IN IMPROVED ACCURACY AND TIGHTER GROUPS.

QUESTIONS? - CONTACT CUSTOMER SERVICE



810-626-3026







HUNTKILLERINSTINCT.COM

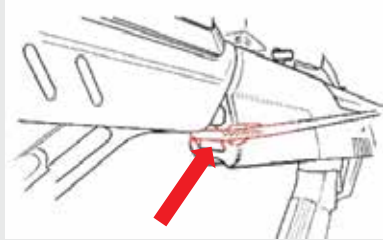
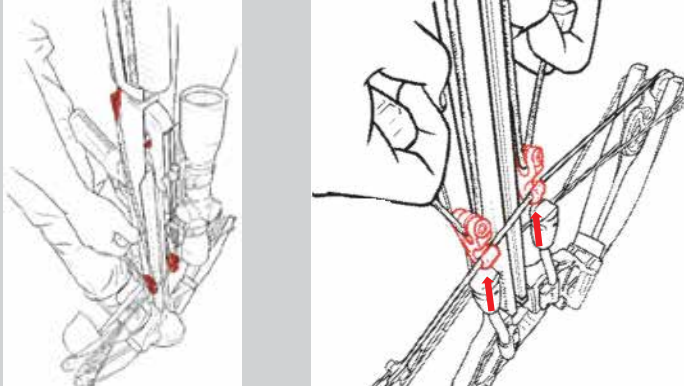

CONTACT@KILLERCROSSBOWS.COM

Page 10 of 18 12-2019-00

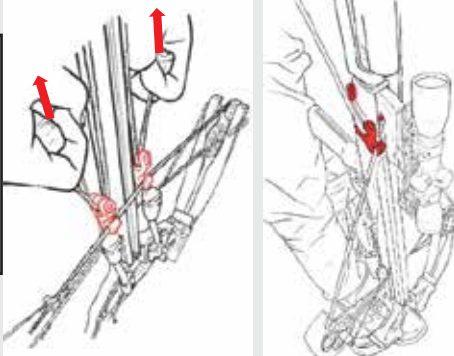
COCKING CROSSBOW (CONTINUED):

STEP	INSTRUCTION	IMAGE
#1	<p>IMPORTANT NOTE: With crossbow unloaded make sure trigger safety is in 'FIRE' position before cocking crossbow. If not in fire string latch will not engage or hold the bow string.</p> <p>With crossbow unloaded, safety in 'FIRE', flight rail, string and cables lubed, place crossbow stirrup on ground (stirrup in front of riser and butt stock up). Insert foot through stirrup so foot extends through stirrup and stirrup rests in middle of foot.</p>	
#2	<p>Hold hooks of Rope Cocker in each hand approximately 4 inches apart with hook opening facing up. Place rope, between hooks, in rope cocker groove on underside of stock as shown.</p>	
#3	<p>Leaning over crossbow extend rope cocker hooks along each side of barrel and attach hooks to crossbow string on each side of barrel. Make sure hooks are facing up. Note – String is closest to string suppressors</p>	
#4	<p>Keeping foot and stirrup flat on ground, grab handles and pull up and back towards your hips (using legs, shoulders and arms) until string fully engages into trigger box assembly. Slowly release tension and remove hooks and Rope Cocker from crossbow. Crossbow is now Cocked.</p>	<div data-bbox="685 1178 956 1429" style="border: 1px solid black; padding: 5px;"> <p>ALWAYS MAKE SURE STRING FULLY ENGAGES TRIGGER BOX BEFORE RELEASING TENSION ON ROPE COCKER.</p>  </div> 
#5	<p>Even though safety automatically engages when cocked, make certain crossbow is in 'SAFE' position (back position furthest from string).</p>	

QUESTIONS? - CONTACT CUSTOMER SERVICE

 810-626-3026

 HUNTKILLERINSTINCT.COM

 CONTACT@KILLERCROSSBOWS.COM

PROPER FINGER, THUMB, AND HAND PLACEMENT:

WARNING

Always keep thumb and fingers below string, flight rail, barrel and behind / below cables.
 Failure to do so may result in serious injury to hand, including possible thumb or finger amputation.



INSTRUCTION

IMAGE

CORRECT

Keep trigger hand on grip behind trigger.
 Always keep other hand securely gripping Forearm Grip with fingers and thumb below strings path, flight rail, barrel and behind / below cables.



INCORRECT

 **THUMB ABOVE BARREL AND IN STRINGS PATH!
DO NOT SHOOT!**



INCORRECT

 **FINGERS ABOVE BARREL AND IN STRINGS PATH!
DO NOT SHOOT!**



INCORRECT

 **FINGERS OR THUMB IN FRONT OR ABOVE CABLES!
DO NOT SHOOT!**



INCORRECT

 **THUMB, FINGERS OR HAND OFF OR BEHIND OR IN FRONT OF FOREARM GRIP AND ABOVE BARREL!
DO NOT SHOOT!**



INCORRECT



 **THUMB, FINGERS ABOVE FINGER/THUMB GUARD!
DO NOT SHOOT!**



QUESTIONS? - CONTACT CUSTOMER SERVICE

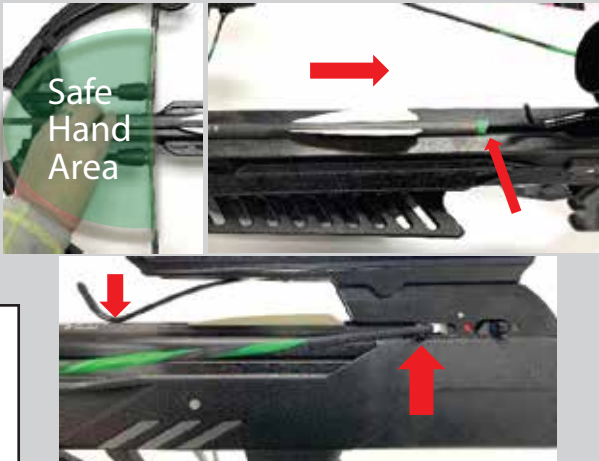

LOADING AND SHOOTING:

STEP	INSTRUCTION	IMAGE
#1	<p>Loading Arrow – Keeping hand in ‘safe hand area’ place a Killer Instinct® recommended crossbow arrow into flight groove on top of barrel (odd color vane down) into flight groove ensuring curve of nock matches curve of string. If not orientate crossbow arrow so nock curve matches string curve.</p> <p>Keeping hand in ‘safe hand area’, slide arrow back under arrow retainer until curve of nock rests solidly next to string.</p> <div data-bbox="128 434 828 598" style="border: 1px solid black; padding: 5px;">  <p>Always keep crossbow aimed in safe direction during loading arrow and when loaded. Before shooting always make sure arrow nock rests firmly next to string to prevent dry firing crossbow, which could cause bodily injury and/or void warranty.</p> </div>	
#2	<p>Shooting – Crossbow is ready to shoot. With fingers/thumb on forearm grip, aim, push safety to ‘FIRE’ position and slowly squeeze trigger to shoot.</p>	 <div data-bbox="335 782 1413 1120" style="border: 1px solid black; padding: 5px;"> <p>Always keep crossbow safety in ‘SAFE’ position until ready to shoot. Always keep thumb, fingers and any other body appendages below and away from flight rail, string, barrel, cables and cams. Never shoot without arrow or arrow firmly next to string. Always keep crossbow aimed in safe direction during loading and when loaded. Always be certain of intended target and what is beyond it before shooting. Never shoot straight up or in any direction that may endanger people or other objects. Never shoot at hard surfaces or at surface of water. Arrow may be damaged, bounce back or ricochet and hit someone or an unintended target. FAILURE TO FOLLOW THESE INSTRUCTIONS CAN RESULT IN SERIOUS INJURY OR DEATH!</p> </div>
#3	<p>Sighting In Scope – Shoot at 10 yards using top scope reticle to confirm you are close to bulls eye. Make windage/elevation adjustments to get closer to bulls eye. Approximately 16 clicks = 1" @ 20 yards. Increase distance to 20 yards and fine tune scope. Continue shooting at additional yardages using lower scope reticles. Lower reticles are for greater distances.</p>	<p>NOTE: Each reticle line represents approximately 10 yard increments (using 390 grain total arrow weight). This may vary with aftermarket arrows and different weight field tips /broadheads</p> <p>SHOOTING TIP: For increased accuracy and tighter groups follow through with your shot by watching arrow hit target through scope.</p>

UNLOADING CROSSBOW:

WARNING

Always use KILLER INSTINCT® recommended arrow to unload crossbow. Do not de-cock crossbow by hand, with cocking rope, crank cocker or by any other means other than shooting an arrow or appropriate discharge arrow.

UNLOADING CROSSBOW:

Recommended and safest way to unload crossbow is to fire arrow into suitable target or rock free ground. If firing into ground, make sure ground is not frozen or hard and shoot at point approximately 4 to 5 feet in front of you at 45 degree angle. Firing at greater distances may result in lost arrow in dirt or ricochet.

TIME ALLOWED TO KEEP CROSSBOW COCKED:

Crossbow can remain cocked 12 hours. Do not leave crossbow cocked overnight or when transporting.

QUESTIONS? - CONTACT CUSTOMER SERVICE

MAINTENANCE, CARE AND STORAGE:

WARNING

Always examine crossbow and crossbow arrows after every shot for worn, loose, damaged or missing parts and cracks or damage to arrows.
DO NOT use worn or damaged crossbow or crossbow arrow(s).
Always store crossbow uncocked and out of reach of children.

SCHEDULE	MAINTENANCE
PRIOR TO EVERY SHOT	Thoroughly check crossbow and crossbow arrow for worn, loose, damaged or missing parts every time you use crossbow. Do not use worn or damaged crossbow or crossbow arrow(s).
PRIOR TO EVERY SHOT	Check and confirm arrow retainer is in good working order as it is designed to apply consistent downward pressure on arrow.
PRIOR TO FIRST SHOT	Lube flight rail with Killer Instinct® rail lube to increase arrow speed and reduce friction to extend life of string, serving and cables.
EVERY 5 – 10 SHOTS	Reapply rail lube on flight rail, string and cables as often as needed or after every 5 to 10 shots.
AFTER INITIAL 20 SHOTS ANNUALLY OR AS NEEDED	Check screws/bolts for tightness on crossbow scope base, scope rings, riser bolt, quiver base and string suppressors.
ANNUALLY OR AS NEEDED	Annually or as needed apply rail lube to cable slide.
IMMEDIATE IF WEAR IS DETECTED	Immediately replace worn, cut or frayed string, serving and cables prior to shooting. Keep string, serving and cables lubed with Killer Instinct® rail lube.
EVERY 2 YEARS	Killer Instinct® recommends replacing string, serving and cables every two years in normal hunting/shooting conditions or sooner if signs of wear exist.
EVERY 3 YEARS	Free 3 year service inspection. Take your crossbow to an authorized KILLER INSTINCT® retail dealer or contact Customer Service at 810-626-3026 or at contact@killercrossbows.com for crossbow inspection and warranty retention.
IMPORTANT	KILLER INSTINCT® and KILLER INSTINCT® authorized dealers are only repair facilities authorized to open or disassemble crossbow or make repairs/replacements of strings, serving, cables, limbs, trigger boxes, barrels, etc. Unauthorized repairs may void warranty. If repairs are needed, contact Customer Service at 810-626-3026 or e-mail support at contact@killercrossbows.com for assistance.

CARE

Keep flight rail, cams, cables, string, trigger box and trigger clean and free of debris, mud, dirt, etc.
After exposing crossbow to damp or wet conditions, completely dry off crossbow before storing.
Do not expose crossbow in excessive heat such as leaving in an automobile on a hot day.

STORAGE

Store crossbow in uncocked position and out of reach of children.
Store indoors in a cool dry location away from excessive heat and moisture.

QUESTIONS? - CONTACT CUSTOMER SERVICE

TROUBLE SHOOTING:

	PROBLEM	SOLUTION
#1	Burning smell after shot	Re-apply Killer Instinct® rail lube to flight rail, string, cables and/or cable slide. Keep fingers out of cable slot on barrel.
#2	String, serving and/or cables are fuzzy	Apply thin coating of rail lube on string, serving and cables and rub lube into string and cables rubbing between your fingers.
#3	String and/or cable serving is coming apart or separating	Do not use crossbow. Replace string and cable or reserve string and cable. Take your crossbow to an authorized KILLER INSTINCT retail dealer or contact Customer Service at 810-626-3026 or at contact@killercrossbows.com for assistance.
#4	String and/or cables are cut or fraying	Do not use crossbow. Replace string and/or cables. Take your crossbow to an authorized KILLER INSTINCT retail dealer or contact Customer Service at 810-626-3026 or at contact@killercrossbows.com for assistance.
#5	Unable to cock crossbow	Make sure the safety is in the "Fire" position prior to cocking the crossbow. If the safety is in the "Safe" position, follow the "Anti-Dry Fire Release Mechanism" on page 9. If questions, contact Customer Service at 810-626-3026 or at contact@killercrossbows.com for assistance.
#6	Additional Problems	Take your crossbow to an authorized KILLER INSTINCT retail dealer, contact Customer Service at 810-626-3026 or at contact@killercrossbows.com for assistance. Visit www.HUNTKILLERINSTINCT.COM for additional information.

CROSSBOW OWNER'S RECORD

FILL IN THE FOLLOWING CROSSBOW RECORD FOR QUICK REFERENCE.

CROSSBOW SERIAL NUMBER:

CROSSBOW MODEL NUMBER:

PURCHASED FROM:

PURCHASED DATE:

IMPORTANT:
 REGISTER YOUR CROSSBOW AND SAVE YOUR SALES RECEIPT AND SERIAL NUMBER. THIS PROOF WILL BE REQUIRED FOR YOUR FREE INSPECTION AND IS REQUIRED SHOULD YOUR CROSSBOW EVER NEED WARRANTY SERVICE. ATTACH SALES RECEIPT TO OWNERS MANUAL FOR SAFEKEEPING.

NOTES:

QUESTIONS? - CONTACT CUSTOMER SERVICE

KILLER INSTINCT® LIMITED LIFETIME WARRANTY*

LIMITED LIFETIME WARRANTY. YOUR KILLER INSTINCT® CROSSBOW IS WARRANTED AGAINST ANY MANUFACTURER DEFECTS FOR THE LIFE OF THE CROSSBOW TO THE ORIGINAL, REGISTERED OWNER. THIS INCLUDES ALL CROSSBOW PARTS EXCEPT STANDARD USE WEARABLE COMPONENTS (STRING, SERVING, CABLES, CABLE SLIDE), ACCESSORIES (RUBBER PARTS, ARROWS/BOLTS, ROPE COCKER, SCOPE, ETC) AND COSMETIC APPEARANCE (SCRATCHES, MARKS, CHIPS) CAUSED BY NORMAL USE AND WEAR. CONTACT YOUR AUTHORIZED KILLER INSTINCT® RETAILER OR CUSTOMER SERVICE AT 810-626-3026 OR E-MAIL AT CONTACT@KILLERCROSSBOWS.COM FOR WARRANTY CLAIMS. ANY AND ALL WARRANTIES, WRITTEN OR IMPLIED, ARE VOID WITH ANY ALTERATIONS TO THE CROSSBOW.

REGISTRATION TO ACTIVATE FREE LIFETIME SERVICE INSPECTION AND LIMITED LIFETIME WARRANTY Register within 30 days of your purchase online at www.HUNTKILLERINSTINCT.com or mail in completed warranty card received at purchase (see bottom of page 18).

FREE LIFETIME SERVICE INSPECTION

Receive a lifetime of free inspections at your KILLER INSTINCT® dealer every 3 years from date of purchase for original registered owner. Free inspection is not transferable. Simply take your registered crossbow with copy of original receipt to an authorized KILLER INSTINCT® dealer every 3 years and they will inspect bow free of cost**. 3 Year Inspection Form is available at www.HUNTKILLERINSTINCT.com

SERVICING YOUR KILLER INSTINCT® CROSSBOW:

If you need repairs, have warranty issues or are up for free 3 year service inspection, take your registered crossbow with copy of original receipt to an authorized KILLER INSTINCT® retail dealer or contact Customer Service at 810-626-3026 or e-mail support at contact@killercrossbows.com for assistance.

The owner is responsible for all shipping costs for crossbows returned to Killer Instinct™ for inspection.

Note: All labor costs associated from maintenance, repairs/replacements resulting from general service or the free lifetime service inspection are the responsibility of the owner.

WARRANTY IS VOID IF

- The KILLER INSTINCT® crossbow is damaged from abuse, mishandling, dry firing, alterations or modifications to the original product.
- The KILLER INSTINCT® crossbow is not registered within 30 days.
- The KILLER INSTINCT® crossbow is not the original owner
- The KILLER INSTINCT® crossbow is older than 3 year from date of purchase and has not received Free Lifetime Service Inspection.

LIMITATION OF LIABILITY

USE ONLY AS INTENDED. MANUFACTURER ASSUMES NO RESPONSIBILITY FOR INJURY, DAMAGE OR LOSS ARISING FROM THE USE OF THIS PRODUCT HOWSOEVER CAUSED.

PLEASE NOTE:

KILLER INSTINCT® reserves the right to make substitutions on warranty coverage for any reason, including but not limited to available parts.

*Limited Lifetime Warranty to the Original Owner.

**Free inspection does not cover labor costs, freight costs, or costs associated with replacement/repair of parts of excluded from Limited Lifetime Warranty.

KILLER INSTINCT® CROSSBOWS
Phone: 810-626-3026
Email: contact@killercrossbows.com
Website: www.HUNTKILLERINSTINCT.com
Shipping/Receiving Address:
413 List St., Suite #2
Frankenmuth, MI 48734



Distributed by:
MSCKI, LLC
P.O. Box 382
Windom, MN 56101

KILLER INSTINCT® is a registered trademark of MSCKI, LLC. ALL RIGHTS RESERVED

QUESTIONS? - CONTACT CUSTOMER SERVICE



810-626-3026



HUNTKILLERINSTINCT.COM



CONTACT@KILLERCROSSBOWS.COM

NOTES:

Lined area for notes





REGISTER ONLINE FOR LIMITED LIFETIME GUARANTEE!

Register at:

[HTTPS://WWW.KILLERCROSSBOWS.COM/REGISTER](https://www.killercrossbows.com/register)

Easy Quick-Step Directions:

1. <https://www.killercrossbows.com/register>
2. Enter in your contact information
3. Enter retailer purchased from, bow model and serial number
4. Click Submit! Now you are covered!

Questions? We can help!

Call us at: 810-626-3026 or

Email: contact@killercrossbows.com

If you cannot register online, completely fill out registration information below, cut out only this portion of the instruction manual, put it into an envelope, place postage on envelope and mail this portion to the address below:

KILLER INSTINCT® CUSTOMER SERVICE
393 List St., Suite B,
Frankenmuth, MI 48734

REGISTERING YOUR KILLER INSTINCT® CROSSBOW BY MAIL

LAST NAME: FIRST NAME:

STREET ADDRESS:

CITY: STATE/PROVINCE:

ZIP/POSTAL CODE: COUNTRY:

PHONE: E-MAIL:

PURCHASE DATE (MONTH / DAY / YEAR):

PURCHASED FROM (DEALER NAME):

SALES PERSONS NAME:

CROSSBOW SERIAL NUMBER:

CROSSBOW MODEL NUMBER:

IMPORTANT:

Register within 30 days of your purchase online at www.huntkillerinstinct.com or mail in completed registration information received at purchase. Retain copy of sales receipt as this is required at time of free inspection and should your crossbow ever need warranty service.